



# Seams

---

# Seams

---

## A. PATTERN MATCHING

Our experience in the manufacturing of patterned material has shown that two closely related factors affect pattern matching. We package, ship and display our products in roll form, but the composition of the materials may result in stretching of the wear layer and the patterns on it. This is caused by bending the material in the process of making the rolls. Stress or stretching during roll-up will vary, depending on how tightly the material was rolled and the location of the individual laps within each roll. The bending stress is four times greater on the lap around a 3" core and two times greater on the lap around a 7" core than it is on the outer lap of a roll that is 12" in diameter.

Some products will experience more bending stress than others. The amount and type of wear layer, thickness of the backing and similar basic construction elements all affect the nature and degree of recovery from bending stresses that each product exhibits when unrolled and flattened out. Regardless of product type, there are several general rules installers should observe when dealing with any patterned material to minimize pattern matching problems.

1. Cut materials from the roll on the day before the material is to be installed. This is important to the conditioning process and takes no longer than cutting it the day of the job. It may take a little reorganizing of the installer's time.
2. Mark the pieces #1, #2, #3 and so on as they are cut from the roll. This marking will keep the pieces in the right sequence and will allow the proper piece to be installed first. Place a piece of masking tape on the same side of each piece as they are cut. This piece of masking tape will identify one side as the trademark side.
3. Pre-match the pieces in the shop, if at all possible. Lay the pieces out in the order they will be installed and check if there is any pattern runoff. If there is not an acceptable match, turn the pieces around and check the match that way. If you start with the trademarked edge of piece #1 to the non-trademarked edge of piece #2 and the match is not acceptable, turn the pieces so the non-trademarked edge of piece #1 is matched to the trademarked edge of piece #2. It does not matter how the first piece is installed in the room. If one way will provide a better match than the other, start that way. Of course, you have this option only before the first piece of material is installed. After the first piece is bonded in place, it is too late to try this procedure.
4. Roll all pieces face-out onto separate rolls having the same diameter. This begins the conditioning process. If all the pieces are rolled to the same size, the bending stress will be uniform and there will be less variation and runoff from piece to piece.
5. Install the pieces in the order in which they were cut from the roll (piece #1, #2, #3, etc.). Install the pieces from the outside of the roll first. If there is a runoff of the pattern, the second piece would be longer than the first piece. If this occurs, you can compress the second piece by rolling it face-in for a short time to shrink the material. If the pieces are installed in reverse order and the second piece is running shorter than the first, there is no way to stretch the material. Rolling felt-backed materials face-in may cause some seam edge curl.

By installing the material in the room with the shortest possible seams, you lessen the chance of pattern runoff. Most patterned material is recommended for residential installations where seams are not as long as those in commercial installations.

If you are using more than one roll on an installation, install the first pieces from both rolls, then the second pieces and so on.

Cutting patterned materials to an exact measured pattern match without regard for the actual stretched match can result in pieces cut too short for matching. Always make job-length cuts on the basis of the length of actual matches in the material being installed rather than on the basis of factory-designated match lengths, such as 18" and 36". For instance, on a pattern with a factory-designated match of 18", the actual stretch match may be 18-1/16". On a 12' length, this could accumulate to a total of 1/2" difference between the measured factory-designated matches and the actual stretched matches. Factory-designated matches do not allow for stretching.

To review:

- Cut material the day before the job.
- Mark pieces #1, #2, #3, etc., as they are cut from the roll.
- Prematch in the shop. If match is off, turn all pieces around.
- Roll all pieces face-out into separate rolls having the same diameter.
- Install pieces in the order they are cut from the roll (#1, #2, #3, etc.). Install pieces from the outside of the roll first.

These steps will practically eliminate mismatch problems. The most critical point is that the pieces be installed in the order they are cut from the roll. Installing pieces out of sequence may cause a pattern match problem.

## B. PATTERN MATCH INDICATORS

### 1. New pattern match indicators will be printed in the selvage edge of select sheet flooring patterns.

Certain non-geometric patterns without grout lines (Fig. 1) will have pattern match repeat indicators printed in the selvage edge. This will help workroom personnel and installers quickly locate the pattern repeat, cut sheet flooring accurately to take to jobs, line up the pattern at seams and locate the proper place to cut the seam. Non-geometric patterns without grout lines can make it difficult to determine what length to cut pieces to take to the job site; and on the job site often make it difficult for the installer to correctly align the pattern at a seam. The pattern match indicators take the guesswork out of these steps, save time in the installation process, and allow for the best possible pattern match at the seams.

The indicators appear as small bars (1/4" wide and approximately 1/2" in length) and occur along both factory edges of 12' wide material. The bars are printed with the darkest ink used in each of the pattern colorations and appear as flat embossed marks that can help to locate the indicator in overall dark patterns (Fig. 2).

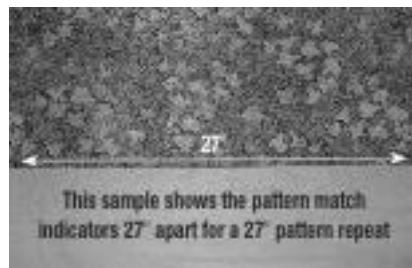

Fig. 1 Urban Settings Cottington



Fig. 2

### 2. How to use the pattern match indicators when matching and cutting seams.

The pattern match indicators do not change the standard good practices that should be followed when installing multiple pieces of flooring, such as rolling each piece individually on the same size core to take to the job site, installing pieces #1, #2, #3 consecutively as they came off the customer roll, etc. Most residential sheet patterns are designed to be installed trademark edge to non-trademark edge (do not reverse pieces).

The pattern match indicator will be cut off along with the rest of the selvage edge when the seam is cut properly (Fig. 3).



Fig. 3

The exact location for cutting the seam is 1/8" into the pattern from the end of the indicator bar. This means that, when double cutting a seam, you will overlap the trademarked edge of piece #2 on top of the non-trademarked edge of piece #1 so that:

- a. The match indicators are aligned across the seam.
- b. The inside end of the top indicator on piece #2 overlaps the inside end of the bottom indicator on piece #1 by 1/4".

The indicator bars are 1/4" wide. This will provide a visual reference for judging when you have the correct amount of overlap of the two pieces. You will also be able to quickly reference the other design elements at this point to ensure correct overlap. If there is some minor runoff in the machine direction, balance it in the center of the seam or in the most inconspicuous location.

Position a straightedge 1/8" away from the end of the indicators on the top piece and cut your seam (Fig. 4). If positioned properly, this seam cut will also be 1/8" away from the end of the indicator on the bottom piece. Both top and bottom seam match indicators will be removed along with an additional 1/8" of pattern along both sides of the seam.

For those installers who straightedge and butt seams, the straightedge should be positioned so that the cut is made 1/8" away from the end of the pattern match indicator on both sides of the seam. This will assure proper match at the seam (Fig. 5). **Please keep in mind that the pattern match indicators need to be removed by the installer during the installation and seaming process.** If a factory edge of the sheet is butted along a straight wall to start the job, be sure that wall base or moldings will cover the indicators so they are not visible in the finished installation. Armstrong Flooring plans to extend this installation aid to new patterns as appropriate.



Fig. 4



Fig. 5

## C. SEAM CUTTING

Seam cutting is one of the most important aspects of flooring installation. It is relatively easy to repair miscuts when fitting most materials, but it is almost impossible to repair a miscut on a seam and make it look like a well-cut seam.

There are three ways to cut seams: double-cut, recess scribe (sometimes referred to as underscribe), and Linocut Seam Cutter..

Cut both pieces of material at seam edges, allowing enough of the pattern on each piece to maintain the proper size grout line at the seam. Cross section #1 shows the proper placement of a seam in material with an embossed grout line. Cross section #2 shows the incorrect placement (Fig. 6).

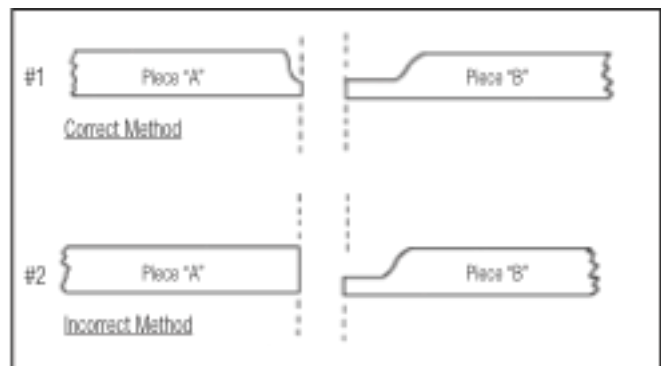

Fig. 6

### 1. Double-Cut Seams

Double-cut seams are generally used on heterogeneous products and felt-backed rotovinyl materials. These are materials that can be cut through two thicknesses in one cut. Install the first piece and bring the second piece into place in the room. It is best if the first piece has adhesive spread under the half along the wall to keep it in place. The seams will be cut dry (without adhesive under them), so the area approximately 1' or 2' back from the seams will not

be spread with adhesive. The second piece is overlapped to the first piece at the factory edge. If you are installing patterned goods, the overlap must be the correct amount so the pattern will match (Fig. 7). Now secure the second piece by spreading adhesive under the half along the wall.



**Fig. 7**

Place a 2"- or 3"-wide piece of scrap under the seam area before the seam is cut. This will save the point of the knife when you cut through the two pieces of material and it will also produce a slight fullness to the seam. This is important because when the two edges are pulled back to finish spreading adhesive under the seam, the face can be compressed, causing the edges to be slightly apart when placed back in the adhesive. After the scrap piece is in place, put the straightedge in place at the area where you want to cut the seam and cut through both pieces in one cut. Hold the knife straight up and down. If you are right-handed, the scrap piece you are cutting off the top should be on your right-hand side. After the adhesive is spread, roll the seam into place. After hand rolling seams in place, roll again with a 100-lb. roller. Apply seam treatments as recommended for the product being installed.

**NOTE:** For S-761 Seam Adhesive Procedure see sections D and E.

## 2. Recess Scribe or Underscribe Seams

This method is recommended for heavier materials that are not easy to cut through in one cut. Recess scribing is the easiest way to cut seams if the installer can cut a good straight edge on the first piece, has set the underscriber correctly, has a sharp knife and can cut on the score line. After fitting the first piece in the room, it should be straightedged with a sharp knife. Hold the knife straight up and down. Keep the scrap on the same side as the hand with which you are cutting. Nonpatterned materials may also be trimmed using an edge trimmer (Fig. 8) or by cutting at least 1/4" off the factory edge. On patterned material, remove the proper selvage using a straightedge and sharp knife.

Fit the second piece of material and obtain proper overlap. With the second piece overlapping the first straightedged piece, insert the recess scriber (Fig. 9). If the scriber is set correctly, the knob on the bottom will follow the straightedged piece, and the pin that is set over the back edge of the knob will mark the top piece directly over the straight edge (Fig. 10).



**Fig. 8**



**Fig. 9**

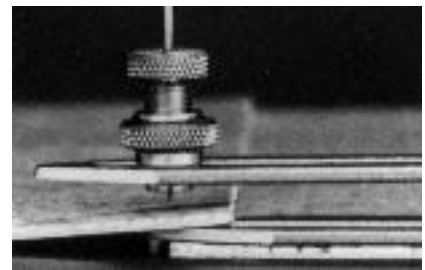

**Fig. 10**

Insert a piece of scrap material face down beneath the scribe mark. Cut the seam using a straight-blade knife (Fig. 11). Hold the knife straight up and down. Keep the scrap on the same side as the hand with which you are cutting. These seams must be cut with the adhesive spread beneath them. One advantage of recess scribing is that you have to spread adhesive only one time. The seam must be cut before the adhesive sets up. The seam edges should lay together with no fullness. They should not have to be forced into place.

After the seam is rolled into place with a hand roller (Fig. 12), remove the burr or rough edge. This burr comes from the recess scriber when the seam is scribed. After the piece is in place, use the back of a knife to skive off the burr (Fig. 13); or, before putting the second piece of flooring in place, hold a small piece of #320 sandpaper at an angle to the cut edge. Move lightly back and forth to remove the burr. After hand rolling seams in place, roll again with a 100-lb. roller.



Fig. 11



Fig. 12



Fig. 13

### 3. Linocut Seam Cutter

This method is recommended for heterogeneous sheet with deep embossing where recess scribing is not practical. After fitting the first piece in the room, it should be straightedged with a sharp knife. Hold the knife straight up and down. Keep the scrap on the same side as the hand with which you are cutting. Nonpatterned materials may also be trimmed using an edge trimmer (Fig. 8) or by cutting at least 1/4" off the factory edge. On patterned material, remove the proper selvage using a straightedge and sharp knife.

Fit the second piece of material and obtain proper overlap. With the second piece overlapping the first straightedged piece, insert the linocut (Fig. 14). The linocut will use the bottom piece as a guide and scribe the top piece.

Cut the seam using a hook-blade knife. Hold the knife straight up and down. Keep the scrap on the same side as the hand with which you are cutting. These seams must be cut with the adhesive spread beneath them. The seam must be cut before the adhesive sets up. The seam edges should lay together with no fullness. They should not have to be forced into place. Roll seam with a hand roller and follow up with a 100-lb roller.



Fig. 14



## **D. S-761 SEAM ADHESIVE PROCEDURE – Residential**

S-761 Seam Adhesive helps reduce installation time significantly compared to traditional seaming methods.

### **1. Materials Needed**

Armstrong Flooring S-761 Seam Adhesive for Sheet Floors

### **2. Modified Loose Lay Installation**

- a. Double-cut the seam before applying the vinyl tape or adhesive.
- b. After seam is cut, fold back both edges and apply the tape or adhesive.
- c. After applying the tape or after proper open time with the adhesive place one side back down.
- d. Using the applicator bottle, apply a 1/8" bead of S-761 Seam Adhesive along the seam edge.
- e. Tuck the seam edge into place, forcing the S-761 Seam Adhesive up through the seam.
- f. Clean adhesive residue from the surface of the flooring using a clean, white cloth dampened with neutral detergent and water.
- g. Roll the seam using a hand roller.
- h. Allow 2 hours before foot traffic and 4 to 6 hours to fully dry for rolling loads.

### **3. S-289 Releasable & Permanent Flooring Adhesive**

- a. Apply the S-289 Adhesive and allow to dry to the touch.
- b. Place pieces down and overlapped to double-cut the seam.
- c. After seam is cut, pull back one side and, using the applicator bottle, apply a 1/8" bead of S-761 Seam Adhesive along the seam edge.
- d. Tuck the seam edge into place, forcing the S-761 Seam Adhesive up through the seam.
- e. Clean adhesive residue from the surface of the flooring using a clean, white cloth dampened with neutral detergent and water.
- f. Roll the seam using a hand roller.
- g. Roll immediately in both directions with a 100-lb. roller.
- h. Allow 2 hours before foot traffic and 4 to 6 hours to fully dry for rolling loads.

### **4. S-288 Flooring Adhesive**

- a. Double-cut the seam dry before applying the adhesive.
- b. After seam is cut, fold back both edges and apply the adhesive.
- c. After proper open time (dry-to-touch over non-porous substrate) place one side back down.
- d. Using the applicator bottle, apply a 1/8" bead of S-761 Seam Adhesive along the seam edge.
- e. Tuck the seam edge into place, forcing the S-761 Seam Adhesive up through the seam.
- f. Clean adhesive residue from the surface of the flooring using a clean, white cloth dampened with neutral detergent and water.
- g. Roll the seam using a hand roller.
- h. Roll immediately in both directions with a 100-lb. roller.
- i. Allow 2 hours drying before foot traffic and 4 to 6 hours to fully dry for rolling loads.

## E. S-761 SEAM ADHESIVE PROCEDURE – Commercial

S-761 Seam Adhesive for Sheet Floors helps significantly reduce installation time compared to traditional seaming methods and allows for a broader range of installer skill sets. It is the required seaming system for residential linoleum installations and an alternative to heat welding in commercial installations of both vinyl sheet flooring and linoleum where an impervious floor covering is not required.

**NOTE: S-761 Seam Adhesive is not recommended in health care operating rooms, procedural rooms or any space where an aseptic environment is necessary. Heat-welded seams are recommended for those types of applications.**

1. Use a recess scribing tool to recess scribe all seams net (Fig. 15).
2. Insert a piece of scrap material beneath the scribe mark. With the scrap on the same side as the cutting hand, cut the seam at a 90° angle. Be sure to hold the knife blade straight up and down (Fig. 16).
3. Remove the scrap piece of material.
4. Using the applicator bottle, apply a 1/8" bead of S-761 Seam Adhesive along the seam edge (Fig. 17).



Fig. 15



Fig. 16

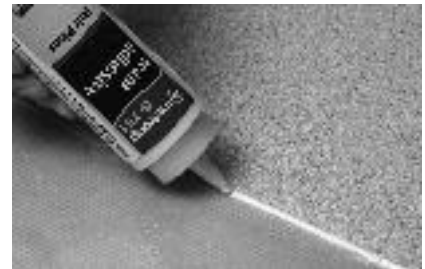

Fig. 17

5. Tuck the seam edge into place, forcing the S-761 Seam Adhesive up through the seam (Fig. 18).
6. Clean adhesive residue from the surface of the flooring using a clean, white cloth dampened with neutral detergent and water (Fig. 19).
7. Roll the seam using a hand roller (Fig. 20).



Fig. 18



Fig. 19



Fig. 20

8. Remove burr at the seam by carefully skiving with the back of the linoleum knife (Fig. 21).
9. Roll immediately in both directions with a 100-lb. roller.





Fig. 21

## F. HEAT-WELDED SEAMS

Heat welding requires the use of special equipment (Fig. 22) and experience with both the equipment and the procedure.

1. Routing machine/power groover
2. Heat-welding hot-air blower
3. Round nozzles (4 or 5 mm) for solid color and round patterned weld rods
5. Armstrong Flooring weld rods (solid color weld rod, round patterned weld rod)
6. Trim plate for spatula knife
7. Skiving tools
8. Hand grooving tools

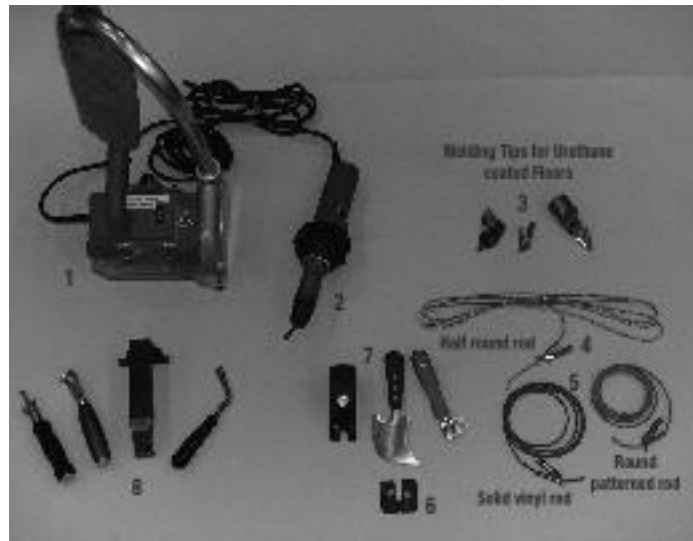

Fig. 22

**SOLID WELD ROD NOTE:** When installing TimberLine, Ambigu, StoneRun, Safety Zone, Medintech, Medintone, Medinpure, Accolade Plus, Rejuvenations Restore, Possibilities or Corlon against any other vinyl sheet flooring at doorways and hallways, seams can be heat welded using solid color weld rod and a 4 or 5 mm round nozzle. Remember to allow the proper drying time for adhesives. Always practice first as nozzles direct heat differently.

## Heat-welding Chart

Material	Setting	Approximate Temperature	Nozzle	
			Round, Solid Weld Rod 164 Lft (50m)	Rounded Patterned Weld 60 Lft (18m)
Medintech Medintone	5 - 7	340° - 450°C (650° - 850°F)	4	5
MedinPure PVC Free	5 - 6	340° - 400°C (665° - 750°F)	3	
Accolade Plus	5 - 7	340° - 450°C (650° - 850°F)	3	
Safety Zone Sheet	5 - 7	340° - 450°C (650° - 850°F)	3	
Possibilities	5 - 6	340° - 400°C (665° - 750°F)	3	
Corlon	5 - 6	340° - 400°C (650° - 750°F)	3	
Timberline Ambigu StoneRun	5.5 - 6	400° - 400°C (750° - 750°F)	3	
Rejuvenations Restore	5.5 - 6	400° - 400°C (750° - 750°F)	3	

All settings have been evaluated using the Leister Hot Air Welding Tool with settings ranging from 1–10. Other manufacturers' settings and temperatures may vary. Practice on a piece of scrap material to determine the correct temperature setting and nozzle required.

**To prevent mistakes on the completed installation, practice on scrap pieces of flooring to find router depth and to fine-tune the heat setting with the tools being used. A welding tool with an adjustable temperature control will make the job easier.**

### 1. Commercial Vinyl Sheet Flooring

#### Commercial Inlaid, Homogeneous

- Flooring installed using the dry-to-touch method may be heat welded immediately. For all other installations, wait a minimum of 10 hours.
- Rout or groove the seams to a depth 1/2 to 2/3 the thickness of the wear layer. **DO NOT expose the backing by routing too deeply** (Fig. 23).

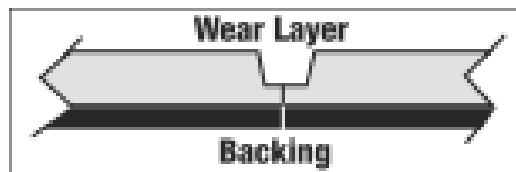

Fig. 23

- The mineral aggregate contained in Safety Zone Sheet will reduce the life of knife blades as well as router blades. When using an electric router, a diamond tip blade is recommended.

#### Heterogeneous

- a. Flooring installed using the dry-to-touch method may be heat welded immediately. For all other installations, wait a minimum of 10 hours.
- b. For Rejuvenations and Rejuvenations Classics rout or groove the seams to a depth 1/2 to 2/3 the thickness of the full structure.
- c. For Rejuvenations Restore product rout or groove the seams to about a depth of 1/3 to 1/2 of the thickness of the full structure. Applying uneven pressure with a hand groover can result in an uneven groove and can make the weld rod appear to vary in width because of the varying depth. To ensure an even groove depth it is recommended to use an automatic router or Turbo sports groover where possible. (Fig. 24)

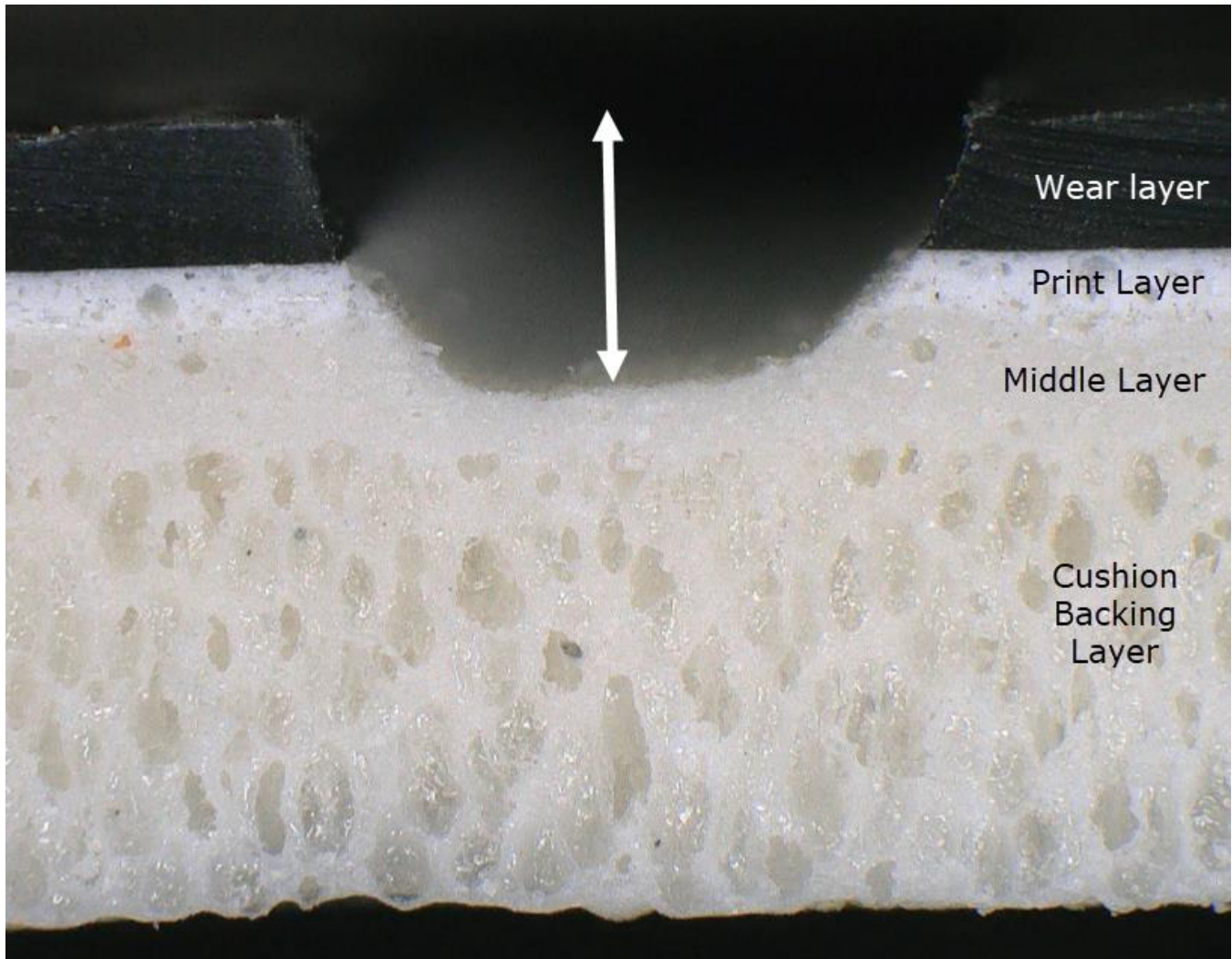

Fig. 24

#### Heat-Welding Instructions for Commercial Inlaid, Homogeneous and Heterogeneous

- a. Use an automatic router equipped with a 3.5 mm (0.1379") thick blade (Fig. 25). In areas where an automatic router cannot be used, use a hand groover (Fig. 26).
- b. Make sure the routed seam is free of dirt, adhesive and particles produced by routing.
- c. Cut the weld rod long enough to weld about 3/4 of the seam.
- d. Set the correct welding temperature and pre-heat welding gun for several minutes.
- e. Attach the appropriate tip (nozzle) to the gun and adjust to the proper temperature. Use of pre-heated welding nozzles will require higher temperatures.

- f. Feed the weld rod through the welding tip and apply the weld rod into the routed seam (Fig. 27).
- g. The heat gun is at the proper angle when the bottom of the nozzle is parallel to the floor. Welding is accomplished by pulling the heat gun slowly toward you.



Fig. 25



Fig. 26

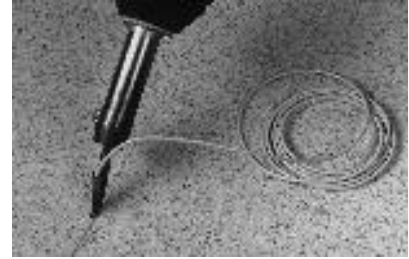

Fig. 27

- h. Control speed so a ridge forms on both sides of the weld rod (Fig. 28). Be careful not to burn or char the surface of the floor.
- i. To stop welding and change directions, first make a ramp. Skive the weld rod 1" to 2" from the end of the welded seam. Using a hand groover, groove the skived section of the weld rod.
- j. Start welding from the opposite direction, continue up the "ramp" and overlap the initial weld for several inches, creating a splice (Fig. 29).
- k. Skiving the weld rod should be done in two passes to minimize concave seams. On the first pass, use a spatula knife and a trim plate, skiving away the top part of the weld rod while it is still warm (Fig. 30).

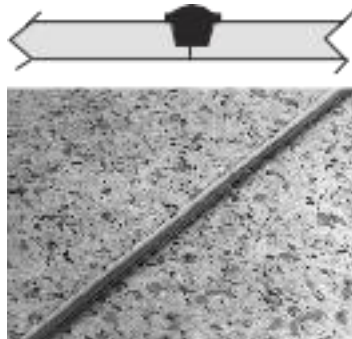

Fig. 28



Fig. 29

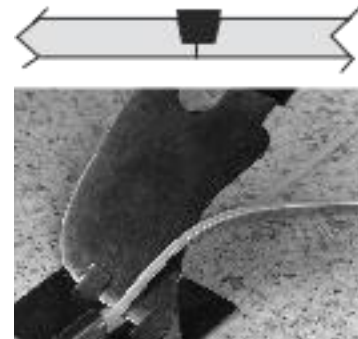

Fig. 30

- l. After the weld rod has cooled to room temperature, remove the remaining excess weld rod on the second pass by holding the spatula knife flush with the flooring (Fig. 31). Smooth, continuous passes result in smooth seams. Repeated stop/start actions result in rough seams. **NOTE: For PVC-Free weld rods apply heat to the surface of the seam to restore the color if stress whitening occurs due to skiving.**

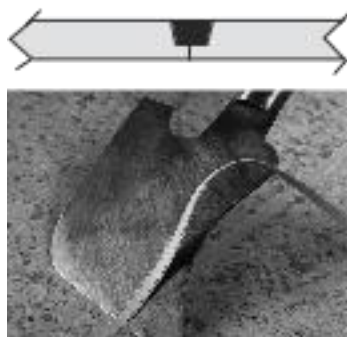

Fig. 31

- m. **Optional for Additional Protection:** After the final skive, wipe the welded seam with a clean, damp cloth. When dry, following the manufacturer's directions, apply a thin, even application of a commercially available, high-quality multi-purpose top coating such as Armstrong S-762 Weld Rod Coating Pen. Use care when applying the finish to avoid over-application onto the wear layer of the adjacent sheet flooring material. In high traffic areas, apply one or two additional coats, making sure the finish is completely dry between applications.

**NOTE: Installers using patterned weld rods for the first time may experience difficulty with the welding rod tearing off. This can happen even though the installer is experienced with welding the round, solid color weld rod. Listed below are some suggestions that will prevent tear-offs and make the patterned weld rod easier to use.**

- n. The heat gun temperature may need to be set slightly higher than the temperature normally used for the solid-color weld rod. A heat gun with an infinitely adjustable temperature control will make the job easier.
- o. After the heat gun has been preheated, attach the nozzle. Starting with a cold nozzle will prevent softening of the weld rod as it passes through the nozzle, and will make tear-offs less likely.
- p. Practice welding to a piece of scrap material before starting your first job. This will allow the installer to determine the proper speed needed to accommodate the higher temperature setting.

## 2. Repairing Heat-Welded Seams

Remove the damaged rod with a hand-grooving tool. If the original seam was grooved using a routing machine, you can easily remove the welding rod with a hand-grooving tool. If the original seam was grooved using a hand-grooving tool, you may have problems with the seam being wider in places and removing the rod with a hand-grooving tool could make the seam even wider and possibly harder to weld with the new welding rod. When grooving the seam, take out the width of the original rod. It is not necessary to groove out the entire depth of the rod. As long as the original rod is firmly bonded, this will not create any problems. Once the seam has been grooved and cleaned out, you can weld the seam with the new rod following the recommended temperature settings for the flooring material. Skive the excess rod from the flooring surface in two passes. On the first pass, skive away the top part of the welding rod using a spatula knife and trim plate while the welding rod is still warm. The welding rod **must be cooled** to room temperature to remove the remainder of the welding rod on the second pass. Remove the remaining rod by holding the spatula knife flush with the flooring surface while skiving.

**NOTE:** If the resilient flooring in the repaired area was being maintained with floor polish (finish) consider applying one or two coats of that same floor polish to the repaired seam. If the original welded seam was being maintained with a field-applied coating for use on welded seams, consider applying a thin, even application of a commercially available, high-quality multi-purpose top coating such as Armstrong S-762 Weld Rod Coating Pen. Use care when applying the finish to avoid over-application onto the wear layer of the adjacent sheet flooring material. In high traffic areas, apply one or two additional coats making sure the finish is completely dry between applications. Always use the finish in conjunction with the manufacturer's recommendation.